

Foundation specifications for

93800050107_V09_en_GB

Engine power, mechanical
Special equipment

MTU 20V4000 GS

GG20V4000A1



kW	2200
-	-

Genset		Value
Engine type	-	20V4000L33
Engine speed	1/min	1500
Torque	kNm	14.0
Genset weight	kg	19700
Distance of resilient mats (a)	mm	1530
Number of resilient mats	-	8
Gear ratio of transmission	-	--
Generator		
Voltage	V	6300
Rating power (temperature rise class F) ¹¹⁾	kVA	2744
Engine speed	1/min	1500
Subtransient reactance	%	16.4
Safety coefficient	-	1.5
Short-circuit torque	kNm	221.8
Static load on foundation (weight)		
Genset load	kN	193.3
Load per side	kN	96.7
Load per resilient mat	kN	24.2
Dynamic load on foundation (imbalance)		
Load per resilient mat	kN	0.5
Load on foundation imposed by short-circuit torque ⁵⁾		
Load imposed by short-circuit torque	kN	145.0
Overall load on foundation		
Load on A side	kN	241.7
Load on B side	kN	-48.3

ATTENTION:

- The maximum admissible height difference of the individual support surfaces is ± 2 mm over 3 m foundation length.

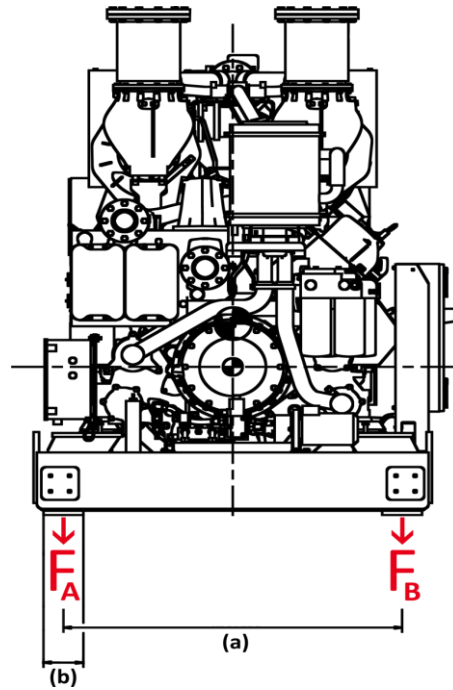

Symbolic illustration

Important information

- The design of the foundation or the load-bearing ceiling (planning, quality, reinforcement etc.) is not part of the scope of delivery. We recommend to source this scope of work to an experienced architect and/or construction company.
- The foundation shall be made of high-quality concrete, if required steel concrete. The concrete shall be poured in a single, continuous operation. The foundation surface shall be screeded in longitudinal and transverse directions using a plate and a level but not corrected by plastering.
- All MTU engines provide full theoretical mass balance.
- Based on the measurement results, the dynamic load resulting from imbalance and transferred from the base frame to foundation was determined as max. 2 % of the static foundation load.
- The stated loads are to be considered for a two-pole short-circuit torque of the generator. This load acts regardless of the direction of rotation alternately with the rotation frequency on both base frame sides (A + B) and is decayed after approx. 0.5 sec.
- It is recommended to mount the genset on resilient mats in order to reduce structure-borne noise. The exact arrangement is specified in the planning drawings. The length l of the resilient mat depends on the admissible load.